



LIZARD

6.5" MONITOR FOR INDUSTRIAL APPLICATIONS

FEATURES:

- » DISPLAY 6.5"
- » OPEN FRAME VERSION



AVAILABLE IN THE RACK VERSION



CUSTOM CONFIGURATION

The Lizard Line is created with the hardware platform configured on the actual need of the customer. Our open frame industrial monitors are designed specifically for industrial use and in particular to be integrated into professional housing systems. All devices are made with high quality components and materials. Open frame products allow customization on customer request to meet different needs.

SUNLIGHT READABLE

The screen is legible even when exposed to intense sunlight, thanks to its high brightness 1000 nits panel with anti-reflective technology.





LIZARD

6.5" MONITOR FOR INDUSTRIAL APPLICATIONS

TECHNICAL DATA:

Display	6.5", TFT - LCD, Resolution 640 x 480, Brightness 250cd/m2	
Connections I/O	1x VGA ,1x DVI(Optional), S-Video(Optional), Composite Video (Optional).	
Power Supply	12VDC (standard) / 24VDC (Optional) / External power supply AC 100~240 VAC (Standard)	
Touch screen	RESISTIVE (Optional)	
Work Environment		
• Temperature environment	Operation Storage	da 0 a +50° C da -20 a +60° C
• Relative humidity	Operation Storage	10% ~ 95% @ 40° C, non-condensing 5% ~ 95%
• Vibration	Operation Storage	2 - 9 Hz: amplitude 3 mm / 9 - 200 Hz: 1G 2 - 8 Hz: amplitude 7,5 mm / 8 - 200 Hz: 2G / 200 - 500 Hz: 4G
Certification	CE, ROHS	

NOTES: Any updates may cause revisions to this datasheet, the manufacturer reserves the right to modify it in whole or in part.

DIMENSIONS:

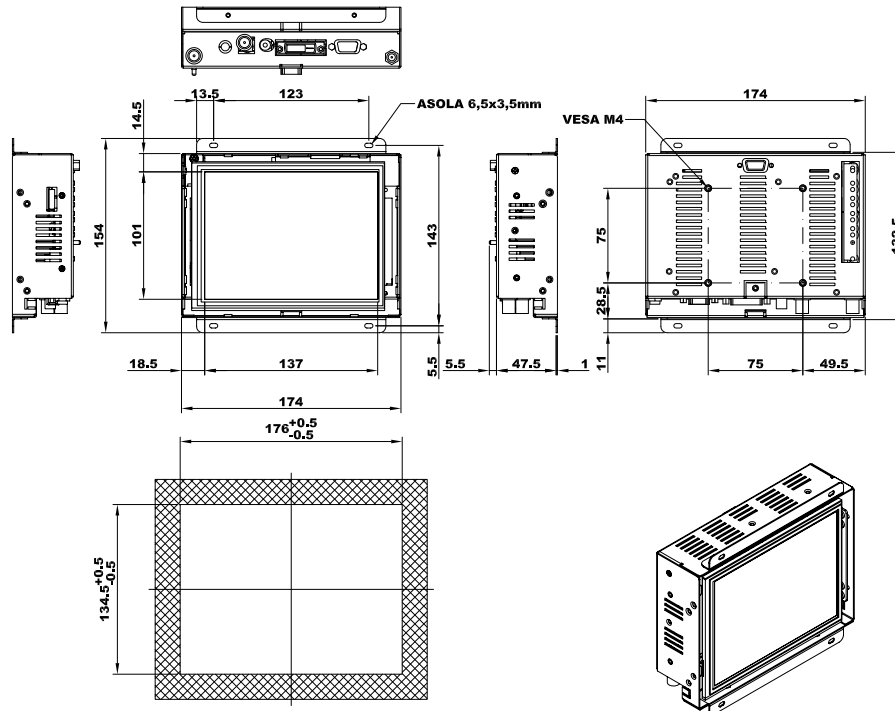

WEIGHT: 1.2 KG

NOTES: These are simplified drawings because some components are not detailed, for more information contact the manufacturer.

