



TAURUS

15" PANEL PC AND MONITOR IP65 - IP67 TOTAL FOR INDUSTRIAL AND FOOD & BEVERAGE APPLICATIONS

FEATURES:

- » DISPLAY 15"
- » TOUCH SCREEN RESISTIVE - PCT - GFG
- » IP67 WATERPROOF AND DUSTPROOF
- » FANLESS SYSTEM
- » INTEL® PROCESSORS
- » EXTENDED TEMPERATURE KIT (-20° +60°)
- » WIFI ANTENNA (OPTIONAL)

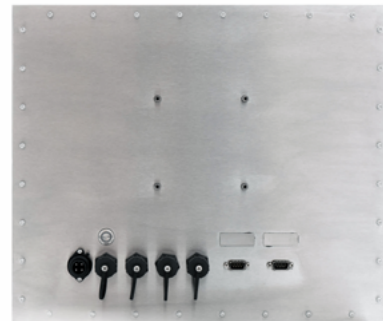

CUSTOM CONFIGURATION

The Taurus line Industrial Panel PCs and Monitors are designed for applications in extreme industrial environments (food & beverage, chemical, pharmaceutical sectors, etc.). Their design complies with IP67 standards and protects the entire system from damage caused by external factors such as water and dust. The solid and resistant structure, therefore, allows use in outdoor environments (intense light conditions or heavy rain), dusty or humid work spaces (food factories) and other more extreme applications (steel mills, processing stations and boats, etc.).

IP67 FRONT PROTECTION

Liquid / dust proof hardware and IP67 rated connectors.

SUNLIGHT READABLE

The high brightness displays (1000 nits) with anti-reflective technology, allow the image to be readable even when exposed to intense sunlight.





TAURUS

15" PANEL PC AND MONITOR IP65 – IP67 TOTAL FOR INDUSTRIAL AND FOOD & BEVERAGE APPLICATIONS

TECHNICAL DATA:

	Monitor Version	Panel Pc Version			
Display	15", TFT-LCD LED Resolution 1024 x 768 Typical Brightness 300 cd/m ²				
System					
• CPU	----	J1900	J4125	i5 5200U	i5 7200U
• Chipset	----	Integrated	Integrated	Integrated	Integrated
• Memory	----	DDR 3 max 8GB	DDR 4 max 8GB	DDR3 max 12GB	DDR4 max 12GB
• BIOS	----	A.M.T. Bios	A.M.T. Bios	A.M.T. Bios	A.M.T. Bios
• Storage	----	128GB – 256GB – 512GB SSD / MSata	128GB – 256GB – 512GB SSD / MSata	128GB – 256GB – 512GB SSD / MSata	128GB – 256GB – 512GB SSD / MSata
Connections I/O					
		IP65 2 x RTL8111H Gigabit LAN; 1 x USB3.0 3 x USB2.0 3 x RS232 1 x RS422-485 (Opt.) VGA HDMI AUDIO	IP65 2 x RTL8111H Gigabit LAN; 1 x USB3.0 3 x USB2.0 3 x RS232 1 x RS422-485 (Opt.) VGA HDMI AUDIO	IP65 2 x RTL8111H Gigabit LAN; 2 x USB3.0 2 x USB2.0 3 x RS232 1 x RS422-485 (Opt.) VGA HDMI AUDIO	IP65 1 x Intel I219V Gigabit LAN; 1 x Intel I211AT Gigabit LAN; 2 x USB3.0 2 x USB2.0 3 x RS232 1 x RS422-485 (Opt.) VGA HDMI AUDIO
	1 x VGA				
	1 x DVI				
	1 x USB for touch (Opt.)				
	1 x RS232 for touch (Opt.)				
	Composite video (Opt. only on IP65)	IP67 3 x USB 2.0/1.1 (MAX); 1 x RJ45 (2 x RJ45 Opt.); 3 x RS232/422/485; 1 x RS232/VGA.	IP67 3 x USB 2.0/1.1 (MAX); 1 x RJ45 (2 x RJ45 Opt.); 3 x RS232/422/485; 1 x RS232/VGA.	IP67 3 x USB 2.0/1.1 (MAX); 1 x RJ45 (2 x RJ45 Opt.); 3 x RS232/422/485; 1 x RS232/VGA.	IP67 3 x USB 2.0/1.1 (MAX); 1 x RJ45 (2 x RJ45 Opt.); 3 x RS232/422/485; 1 x RS232/VGA.
Expansions	----	1 x Mini PCI-E (Internal)	1 x Mini PCI-E (Internal)	1 x Mini PCI-E (Internal)	1 x Mini PCI-E (Internal)
Wireless lan	With IP67 external antenna				
Touchscreen	RESISTIVE / CAPACITIVE / GFG				
Power Supply	12VDC (standard) / External power supply AC 100 ~ 240 VAC (Standard) / 24VDC (Opt.)				
Work environment					
• Temperature environment	Operation Storage	from 0 to + 50 ° C -20 to + 60 ° C			
• Range operating extended	Optional	from -20 to +60° C			
• Relative humidity	Operation Storage	10% ~ 95% @ 40° C, non-condensing 5% ~ 95%			
• Vibration	Operation Storage	2 - 9 Hz: 3 mm amplitude / 9 - 200 Hz: 1 g 2 - 8 Hz: amplitude 7.5 mm / 8 - 200 Hz: 2 g / 200 - 500 Hz: 4 g			
IP Protection	IP65/IP67				
Certification	CE, ROHS				
Operating system	Windows® 7 / Windows® 8.1 / Windows® 10 IOT Enterprise (LTSP, LTSC, SAC) / Windows® 11 IOT Enterprise (CBB)				

NOTES: Any updates may cause revisions to this datasheet, the manufacturer reserves the right to modify it in whole or in part.





TAURUS

15" PANEL PC AND MONITOR IP65 - IP67 TOTAL FOR INDUSTRIAL AND FOOD & BEVERAGE APPLICATIONS

DIMENSIONS: Pc IP65 version

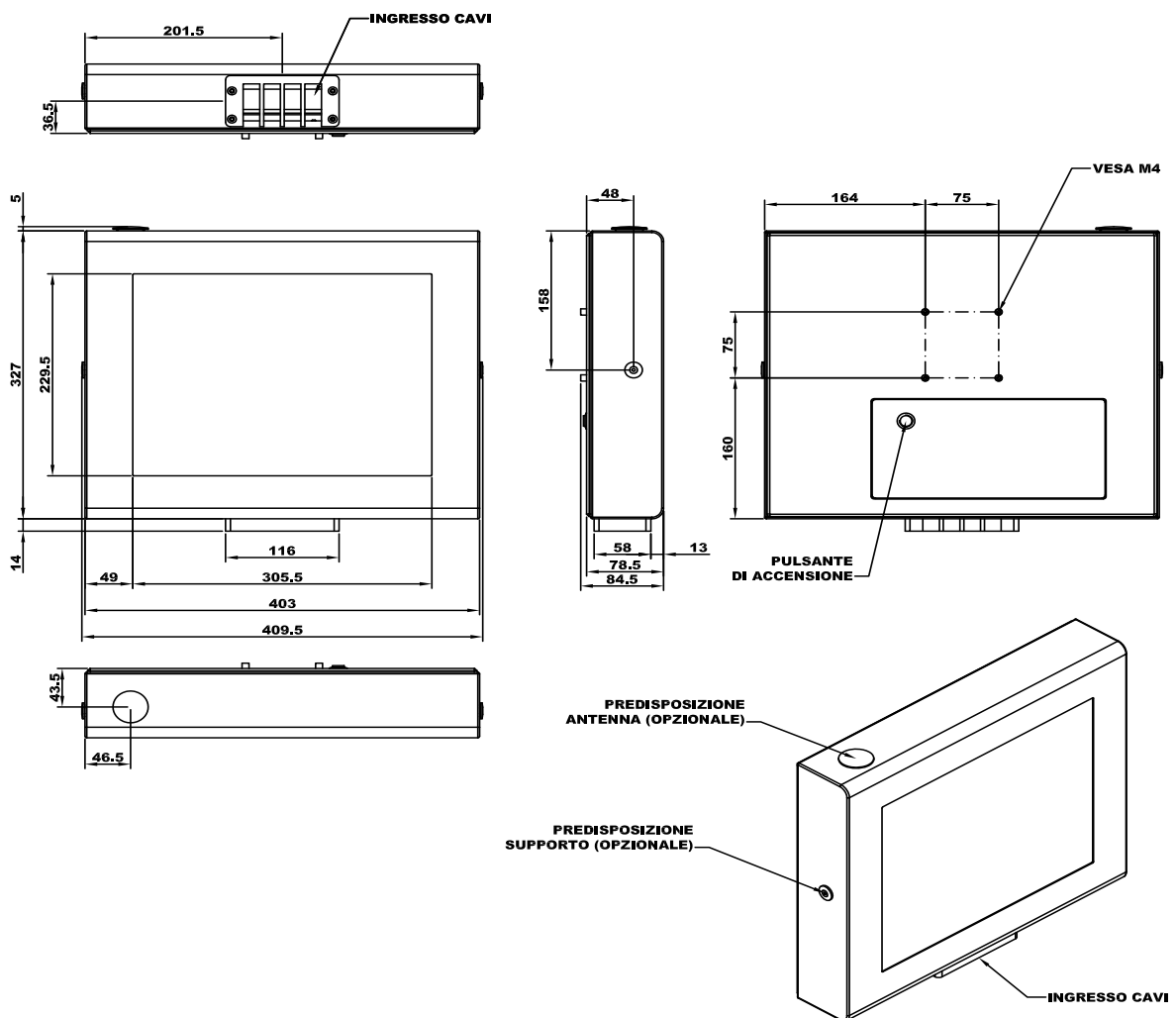

NOTES: These are simplified drawings because some components are not detailed, for more information contact the manufacturer.





TAURUS

15" PANEL PC AND MONITOR IP65 - IP67 TOTAL FOR INDUSTRIAL AND FOOD & BEVERAGE APPLICATIONS

DIMENSIONS: Pc IP67 version

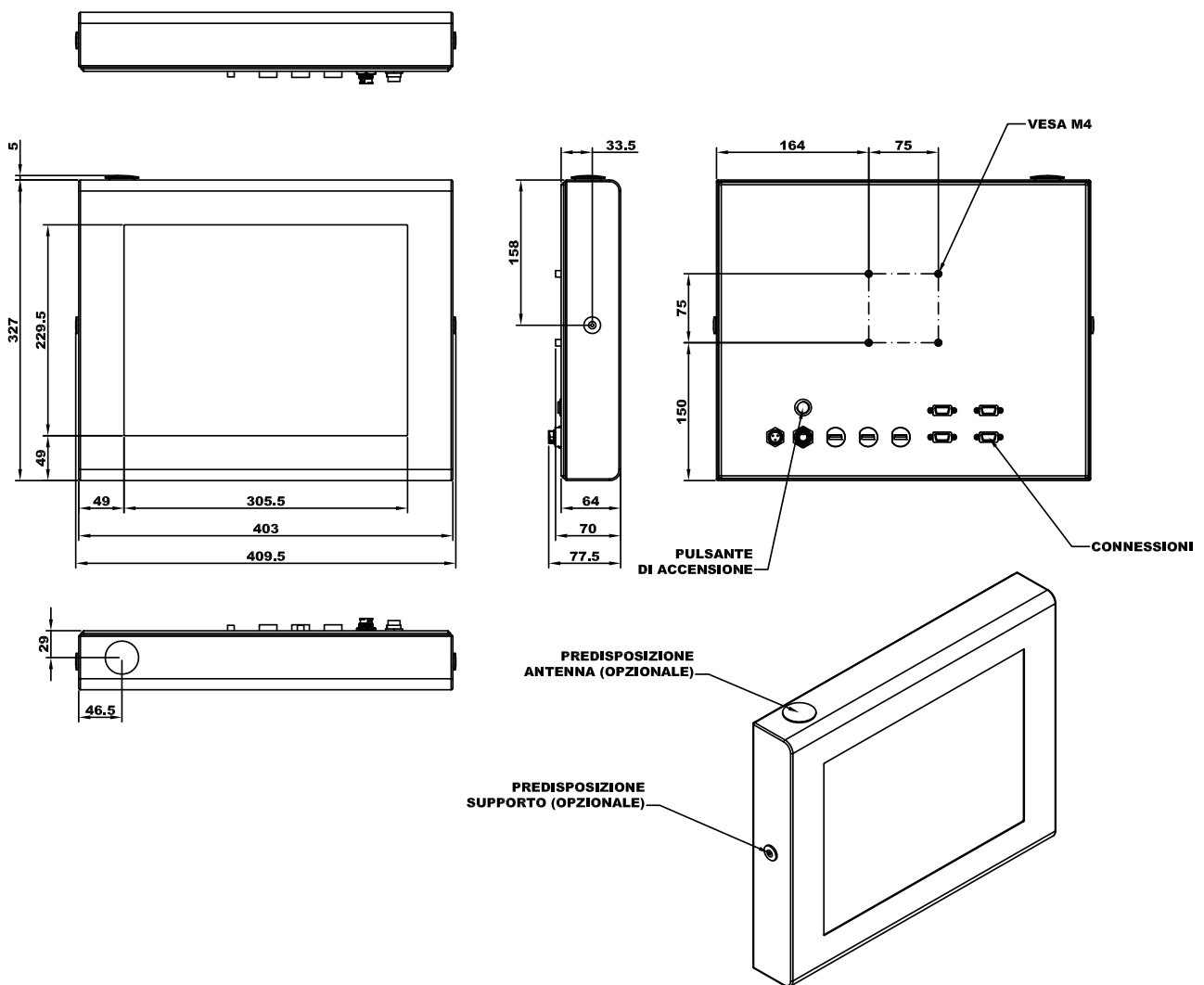

NOTES: These are simplified drawings because some components are not detailed, for more information contact the manufacturer.





TAURUS

15" PANEL PC AND MONITOR IP65 - IP67 TOTAL FOR INDUSTRIAL AND FOOD & BEVERAGE APPLICATIONS

DIMENSIONS: Monitor IP65 version

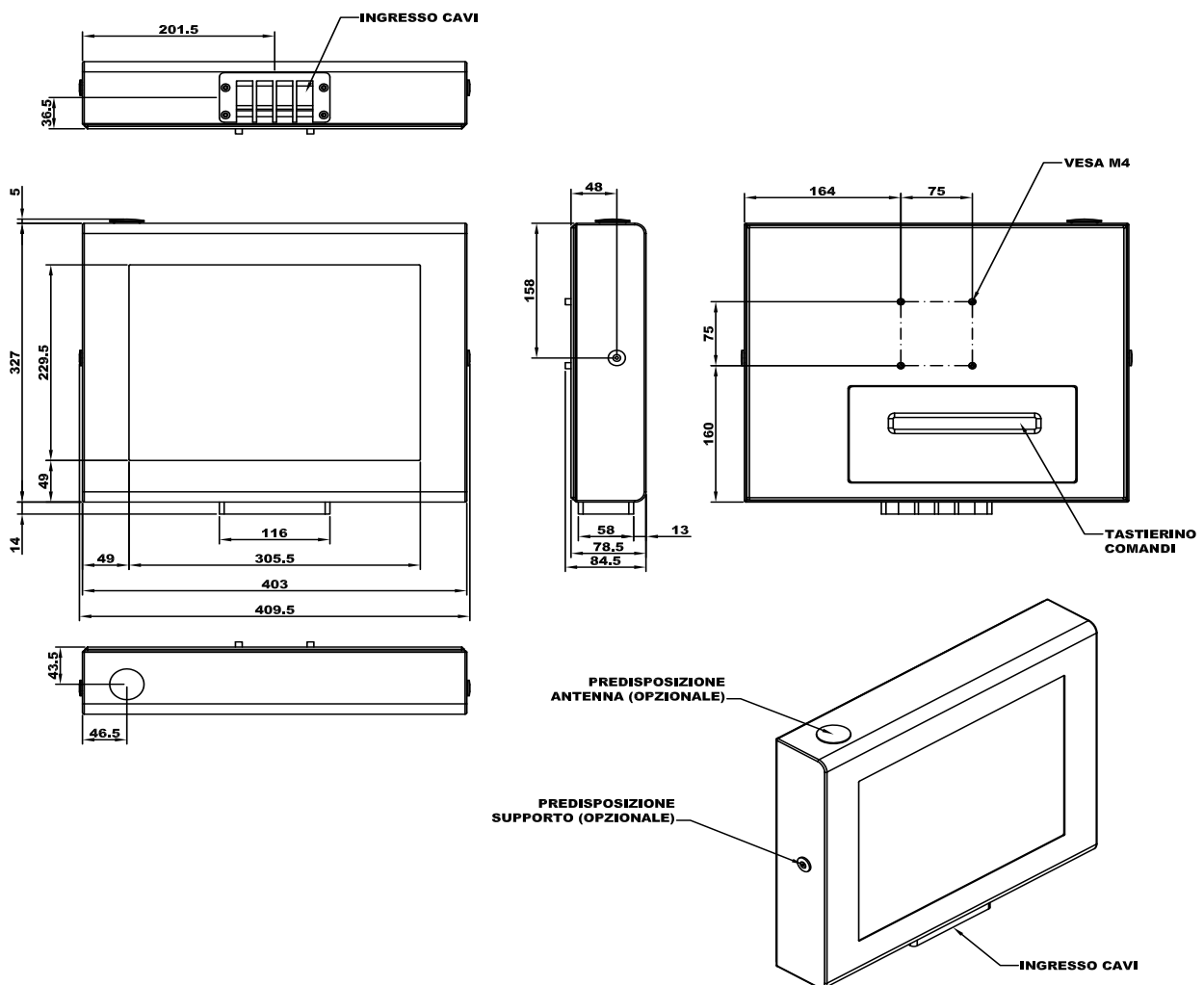

NOTES: These are simplified drawings because some components are not detailed, for more information contact the manufacturer.





TAURUS

15" PANEL PC AND MONITOR IP65 - IP67 TOTAL FOR INDUSTRIAL AND FOOD & BEVERAGE APPLICATIONS

DIMENSIONS: Monitor IP67 version

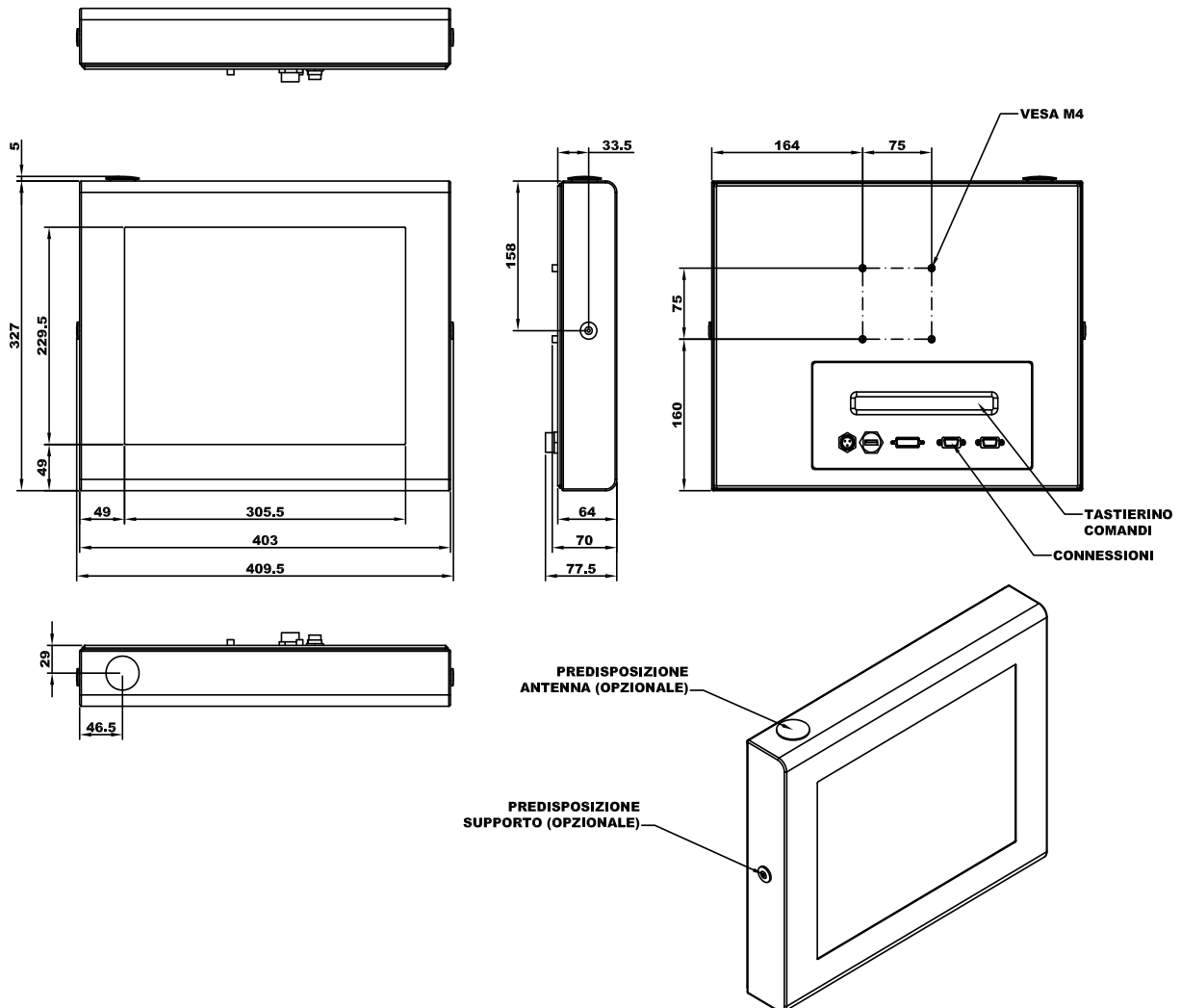

NOTES: These are simplified drawings because some components are not detailed, for more information contact the manufacturer.

